

VICTORIO STRAINER

NO. 200

instruction
booklet

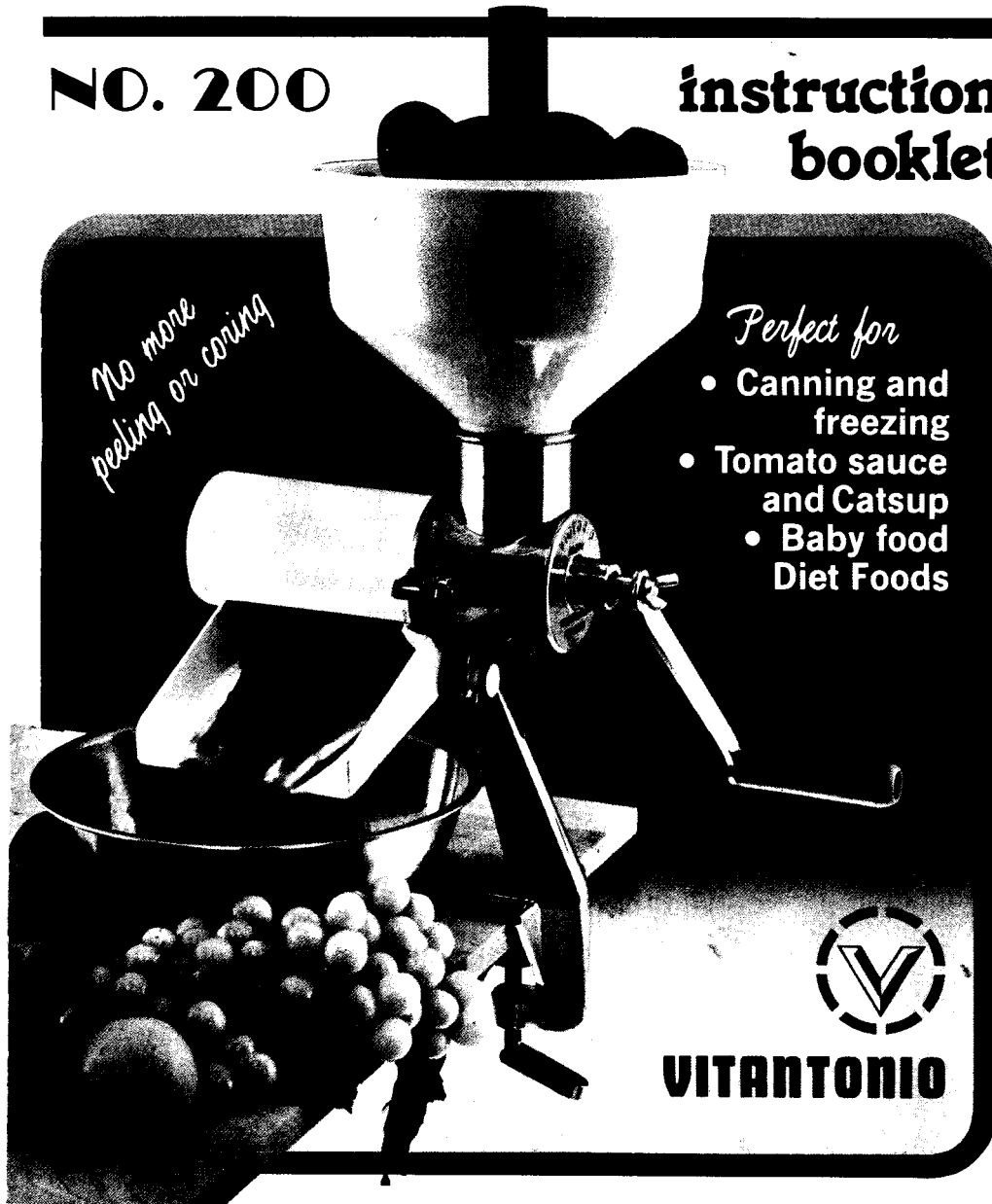

VICTORIO™ instructions

Introduction.

Your new Victorio Strainer is both a money saving investment and a giant step towards healthier, more flavorful home cooking. Why purchase high priced, commercially processed foods when you can easily can and freeze your own foods? And you will enjoy the natural, wholesome goodness and flavor from your home-canned foods that will be free from all the usual additives, as well.

The Victorio has thirty years of design and manufacturing experience behind it. The simplicity of its construction and the use of the most up-to-date materials make the Victorio a long lasting and smooth operating strainer. It is an invaluable time-saving addition to your kitchen and will provide years of trouble free service.

How to assemble your Victorio.™

Before using your Victorio, wash and dry all the parts thoroughly. Clamp the body to your counter or table top for assembly.

- 1.) First assemble the shaft, spring and cup as shown, making sure that the spring is fitted into the open end of the cup.
- 2.) Put the rubber washer in place along the inside of the collar on the screen assembly, and place the spiral inside the screen. Insert the square end of the shaft assembly into the square hole inside the spiral.
- 3.) Now fit the entire screen, spiral and shaft assembly into the body, guiding the shaft through the bushing in the body. Place the screen screws into the slotted lugs on the body and tighten the wing nuts until the rubber washer is tight against the body. Push the hopper into the opening in the top of the body until snug.
- 4.) Attach the handle to the shaft with the handle nut. Slide the Squirt Guard over the screen, align the tightening screw into the slotted lug and tighten.

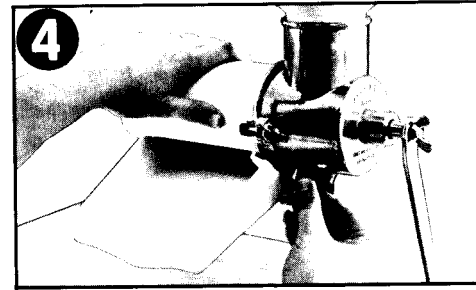
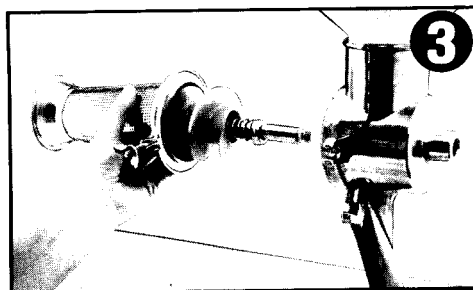
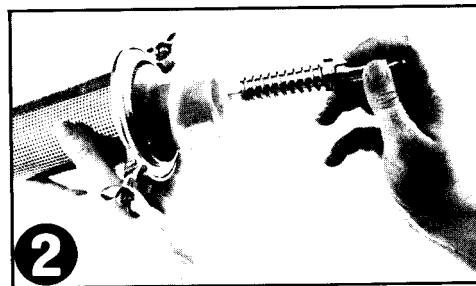
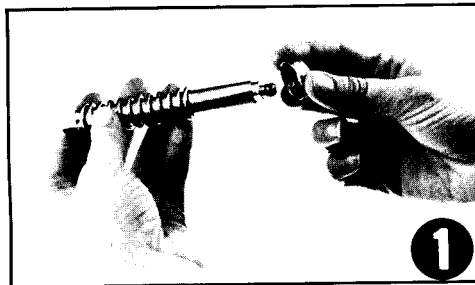

No more peeling or coring

Useful tips.

- 1.) There is no need to make any adjustments to your Victorio.
- 2.) The Spiral will turn more smoothly when fruits or vegetables are fed into the Strainer.
- 3.) The Squirt Guard may be removed if necessary when processing drier foods such as beans or potatoes.
- 4.) After use, disassemble the Strainer and wash all the parts. Dry thoroughly, reassemble and store in the original carton.

Quick and easy to use.

Before you begin straining, always wash your foods thoroughly first. Two bowls are needed: one for the puree and one to collect the waste. You may use the freshly strained purees immediately or preserve them for later use by canning, freezing or dehydrating. Whenever preserving any foods by any method, always consult a reliable source for guidance since improper methods of preserving can be dangerous. Here are several popular uses for your Victorio:

TOMATO PUREE

There's no substitute for the fresh taste of homemade tomato sauce. Start with whole, ripe tomatoes. Wash, remove the stem ends and quarter. Run the tomatoes through the Strainer. The seeds and skin will separate from the puree. Now the puree is ready for the saucepot to be seasoned according to your favorite recipe and simmered until desired texture is reached. The sauce can then be served or frozen in small containers for later use.

APPLESAUCE

Use ripe apples. Wash, remove stems and quarter. There is no need to remove skin, core or seeds. Steam the sections in a covered pot for about 30 minutes until they are soft. Drain the sections of excess water and process through the Strainer. Certain varieties of apples may require further softening in order to prevent jamming.

GRAPE JUICE

A unique feature of this strainer is its ability to process grapes using no. 200-21 Grape Spiral, available separately. (See page 5.) Wash the grapes and remove the stems. Using the Standard Screen provided with the Victorio, process the grapes. You may wish to process the pulp a second time to extract some of the remaining juice. You will find the Victorio useful for making grape jams, jellies and wine.

PUMPKIN AND SQUASH

The Pumpkin Screen no. 200-22, available separately, (see page 5,) is most ideal for processing pumpkin and squash. Wash and remove stem, blossom and seeds. Cut into small sections and steam until soft. Process through the Strainer. The puree is now ready to use for making pie fillings, delicious breads or side dishes.

BERRY JUICE

The Berry Screen no. 200-20, available separately, (see page 5,) is recommended for most varieties of berries that have very small seeds. Elderberries have a very sticky pulp and should be avoided since they may cause jamming.

Wash the berries and remove the stems. Process through the Strainer. The seeds and skins will separate from the puree. The puree is now ready for making jams, jellies, dessert toppings, pie fillings, fruit leathers and even wine.

BABY FOODS

There are many reasons why many families are making their own baby food with their Victorio Strainers. Consider wholesome, fresh fruits and vegetables free from fillers and additives. Consider the money savings. Your Victorio will pay for itself in the first few weeks of feeding. Your baby will be happier with healthier and better tasting food, too!

Simply process soft cooked fruits and vegetables through the Strainer. Any tough fibers that are difficult for baby to digest will separate from the puree.

BEANS

Try Mexican Refried Beans, which you can serve topped with melted cheddar cheese as a side dish or use them to make bean burritos or enchiladas. Just process cooked Pinto or Kidney beans through the Victorio and place in a skillet with chopped onions, garlic and bacon drippings for "refrying."

There is a middle eastern dish that is currently becoming very popular in this country. It's called Houmus. Process soft cooked Garbanzo beans through the Victorio. Mix in a dash of sesame seed oil and lemon juice. Top with Paprika and garnish with parsley for an interesting hors-d'oeuvres or appetizer. Serve with small pieces of "pitta" bread.

POTATOES AND CORN

You may wish to use your Victorio to simplify making mashed potatoes for a large family or gathering. Just quarter potatoes. There is no need to peel. Cook until tender. Strain potatoes and add milk, butter and salt to taste.

Cooked corn can be processed to make creamed corn or a delicious corn chowder.

TOMATO AND VEGETABLE JUICES

Tomato juice can be made easily from fresh juicy tomatoes. Follow the same procedure as given above for processing fresh tomatoes for tomato puree. Then add water and seasoning as desired for a fresh tomato juice.

Juice can also be made from hard vegetables such as carrots and celery. Wash the vegetable thoroughly and remove any stems. Cut into small pieces and steam until soft. Process through the Strainer and add water and seasoning to the puree to make juice. Try any combination of vegetables for an interesting vegetable drink.

TO MOTORIZED YOUR VICTORIO.

For those who wish to motorize their Victorio, an interchangeable shaft no. 200-19, suitable for attaching a pulley, is available as an accessory. (See page 5.) Extra care should always be used when constructing any motorized unit. Any moving parts, such as belts and pulleys, should be enclosed to protect yourself and others from possible injury.

Never feed a motorized unit by hand. Always use the Plunger provided.

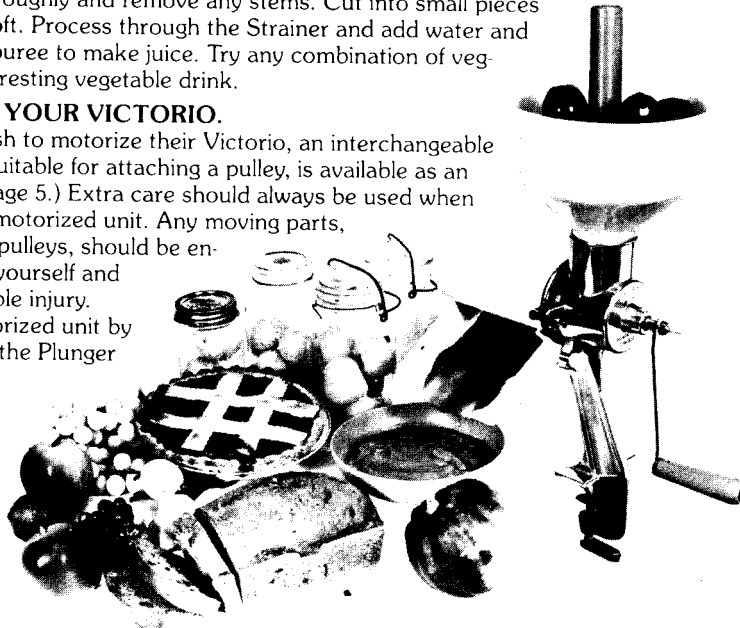

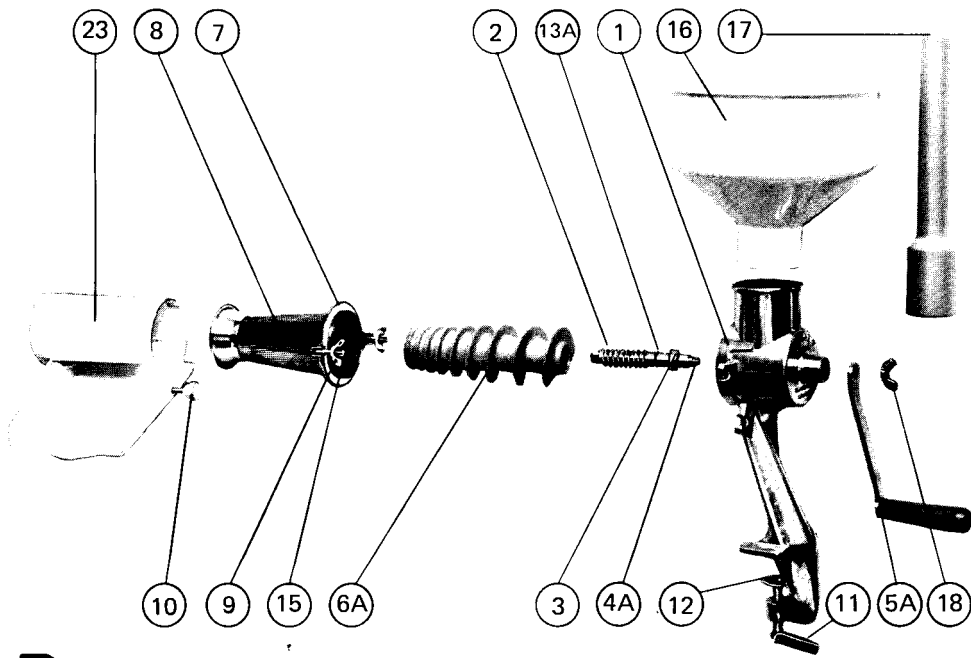

Parts.

MODEL No. 200 VICTORIO STRAINER

DIAGRAM NO.	DESCRIPTION	PART NO.	PRICE EACH
1	Body including Clamp Assembly	200-1	\$11.90
2	Spring	200-2	1.10
3	Cup	200-3	.90
4A	Shaft	200-4A	3.50
13A	Seal Ring	200-13A	.70
5A	Handle Assembly	200-5A	2.30
6A	Standard Spiral	200-6A	7.50
7	Washer	200-7	.80
8	Standard Screen Assembly, 1/16" holes	200-8	10.00
9	Wing Nut	200-9	.60
10	Tightening Screw	200-10	.90
11	Clamp Screw and Lever Assembly	200-11	3.00
12	Clamp Button	200-12	.60
15	Wing Screw	200-15	.70
16	Hopper	200-16	5.50
17	Plunger	200-17	2.00
18	Handle Nut	200-18	.70
23	Squirt Guard w/Tightening Screw	200-23	7.50

When ordering parts, specify part number and model number of strainer.

ADD \$2.00 FOR HANDLING CHARGES. NO C.O.D.
SEND CHECK OR MONEY ORDER

CANADIAN ORDERS: ADD \$3.50 FOR POSTAGE AND
HANDLING. REMIT IN U.S. FUNDS.

Accessories.

Here are several accessories available for your Victorio Strainer model no. 200. When ordering accessories specify part no. and model no. of strainer.

ADD \$2.00 FOR HANDLING CHARGES. NO C.O.D.
SEND CHECK OR MONEY ORDER

CANADIAN ORDERS: ADD \$3.50 FOR POSTAGE AND HANDLING. REMIT IN U.S. FUNDS.

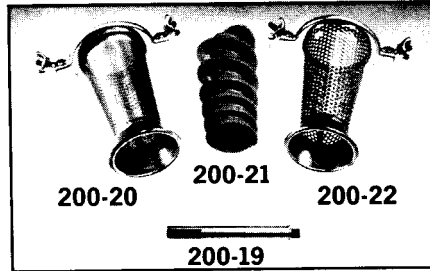

ACCESSORIES	PART NO.	PRICE EACH
Pulley Shaft	200-19	\$ 5.95
Berry Screen Assembly, 3/64" holes	200-20	11.50
Grape Spiral	200-21	8.50
Pumpkin Screen Assembly, 1/8" holes	200-22	11.50

Other fine products.

VITANTONIO MFG. CO. features many useful and time saving canning aids: Bean Slicers, Apple Parers, Cherry Stoners, Fruit Press and Crusher, Pea Sheller, Grain Mills, Bottle Corkers and Capper, and more.

<p>STONE MILL No. 315</p> <p>GRAIN MILL No. 294</p>			<p>CHERRY STONER No. 287</p>
<p>BARONA GRATER No. 500</p>			<p>BEAN CHOPPER No. 299</p> <p>BEAN SLICER No. 296</p>

See your dealer or write to:

VITANTONIO MFG. CO.

DEPT. A 34355 VOKES DRIVE EASTLAKE, OH 44094